SeaLand® VACUUM TOILET OWNER'S MANUAL

**VacuFlush® 500 Plus and 1000 Series,
Model 706 Toilets**



IMPORTANT NOTICE

VacuFlush® sanitation systems must be installed according to Dometic's recommended procedures. Do not attempt installation without first contacting a SeaLand Product certified dealer or Dometic Corporation.

! WARNING

This manual must be read and understood before adjustment, maintenance, or service is performed. Modification of this product can result in property damage.

 **Dometic** 

Dometic Sanitation Corporation
13128 State Rt 226, PO Box 38
Big Prairie, OH 44611
SeaLand Product Customer Service: 1-800-321-9886
(8:00 a.m. - 5:00 p.m. ET)

TABLE OF CONTENTS

	Page		Page
Product Features	2	Toilet Model Identification	7
Marine Sanitation Regulations	3	Pedestal and Pedal Cover Installation	7
Important Information Before Operation	3	Deodorants and Special Tissue	8
Key System Components	4	Accessories	9
System Start-Up	5	Vacuum Tester	9
Proper Bowl Cleaning	5	Service Tip	9
Winterizing	5	Troubleshooting Guide	10 - 12
Clearing Discharge Lines	6	Dimensional Specifications	13
Maintenance	6	Wiring Diagrams	14
Spare Parts	6	Parts Distributors	15
VacuFlush Maintenance Kit	7	Warranty	16
Ordering Parts	7		



WARNING – HIGH VOLTAGE SYSTEM.
Turn off electrical power before servicing.



WARNING – PUMP STARTS AUTOMATICALLY.
Turn off electrical power before servicing.

PRODUCT FEATURES

Dometic brings the technology, comfort and efficiency of VacuFlush Sanitation Systems in an easy-to-use and easy-to-maintain package.

- **Freshwater Flush**
 - Eliminates the unpleasant sulfide odors which plague saltwater systems.
 - Significantly extends life of system components by eliminating saltwater and impurities from accumulating in the system over time.
- **Improved Flush Ball Seal**
 - Enhanced Teflon® coating for longest-lasting water sealing performance.
 - Resists hard water mineral build-up.
- **Efficient Design**
 - Consumes a little over a pint of water per flush and allows boat owners to use a small waste tank. Fills a 10-gallon (28.4 L) tank in same time that an electric toilet fills a 40-gallon (113.6 L) tank.
 - Uses only 4-6 amps per flush on 12 VDC.
- **Delightful Operation**
 - Simple one-lever flush control. No complex instructions needed.
 - Comfortable adult-sized seat.
 - Large water surface maintains clean bowl.
 - Vitreous china bowl.
- **Reliability**
 - USCG Certified Type III Marine Sanitation Device.
 - No impellers or macerators – vacuum pump can run dry without burning up. No dynamic seals.
 - Vacuum generator design eliminates clogging problems associated with other systems.
- **Dispose of Sewage Conveniently and Safely**
 - Toilet can be used without discharging sewage into sensitive waters.
 - Holding tank discharge is at a dockside pump or at sea with optional overboard discharge.
 - No portable toilet tanks to haul or dump.
- **Backed by the Best in Service and Quality**
 - The VacuFlush system is from the leader in marine sanitation.
 - Worldwide parts availability and technical backup.

Dometic reserves the right to change specifications without notice.

MARINE SANITATION REGULATIONS

All boats with fixed toilets in U.S. waters and in the waters of some other countries are required to be equipped with an operable marine sanitation device (MSD). The VacuFlush system is a holding tank or Type III system as defined by the U.S. Coast Guard.

Type III systems are designed to permit operation of the toilet without the direct discharge of untreated waste after every flush. This means onboard toilet facilities can be used when the boat is near swimmers, beaches or shellfish beds.

Type III systems can be discharged at marina dockside pump-out stations or, if in coastal waters, a minimum of three miles offshore. **Overboard discharge capability must remain secured while within the three-mile limit.** The overboard discharge pump is activated by a keyed switch located in the toilet compartment. **This key should be removed at all times except when discharge pump is operating.**



Sewage from any source should not be discharged directly into our waters. If you are interested in learning more about this issue, please contact Dometic at the phone number or address listed on the back page of this manual. Request Clean Water Notebook, Volumes 1 and 2.

IMPORTANT INFORMATION BEFORE OPERATION

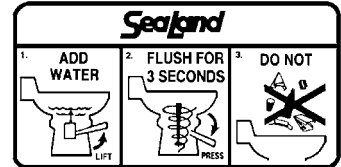
1. Fill freshwater tank and add deodorant to holding tank through toilet bowl. (See System Start-Up Section, page 5.)
2. Make sure all guests understand the operation of the VacuFlush system and the instruction label is in plain sight and easy for guests to read. **If this label is not included in this manual, please contact the SeaLand Product Customer Service Department immediately.**
3. Remember the vacuum pump starts automatically. Shut off the system before servicing and do not leave the boat with toilet system breaker on.
4. **Never use drain openers, alcohol, solvents, etc. in the system.**
5. If the system does not function properly, refer to the Troubleshooting Section of this manual and repair as necessary. If problem persists, contact your local SeaLand dealer or see the Parts Distributor section of this manual.

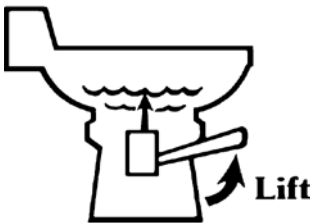
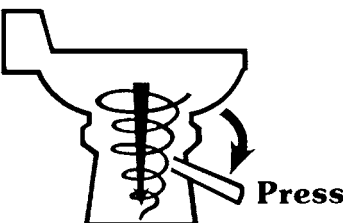

NORMAL OPERATION

<p>1. To add water to the toilet before using, raise flush lever until desired water level is reached. Generally, more water is required only when flushing solids.</p> 	<p>2. To flush toilet, press flush lever sharply down to the floor until contents clear bowl. A sharp popping noise is normal when the vacuum seal is broken and flushing action begins. Be sure to hold lever down for three (3) seconds. If flush lever is accidentally released before waste clears bowl, do not attempt to flush toilet again until vacuum pump stops running. A small amount of water should remain in the bowl after flushing.</p> 	<p>3. Do not dispose of sanitary napkins or other non-dissolving items in toilet, such as facial tissue or paper towels. These items can cause plugging of the system. Refer to the Deodorants and Special Tissue section in this manual for more information.</p> 
---	---	--

KEY SYSTEM COMPONENTS

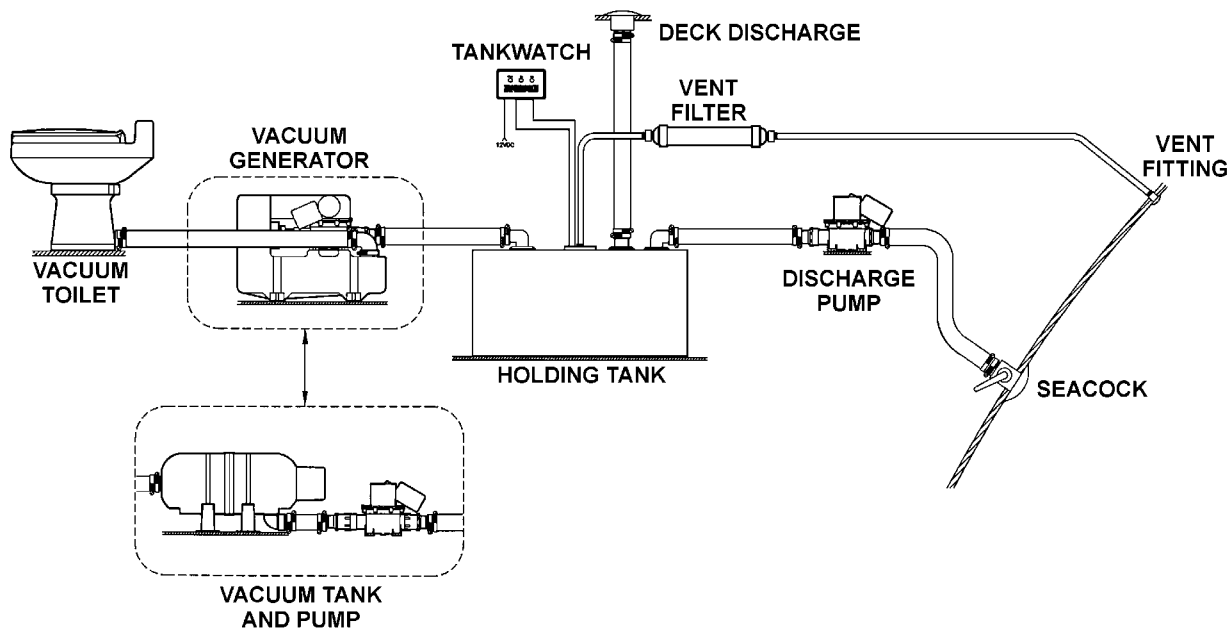

Vacuum Toilet: The VacuFlush toilet operates in a way different from other marine toilets. VacuFlush systems use a small amount of water (a little more than a pint or .5 liter) per flush in addition to a simple vacuum. The toilet is connected to a pressurized freshwater system. Fresh water is the key to an **odor-free bathroom compartment**. VacuFlush toilets are equipped with an integral vacuum breaker which prevents the possible contamination of the potable water supply.

Vacuum Tank: The vacuum tank stores vacuum energy. System vacuum level is monitored by a vacuum switch located on the vacuum tank. When this switch senses a drop in vacuum in the system, it automatically signals the pump to energize and bring the vacuum to operating level. This process is normally completed in less than one minute. In a properly operating system, the stored vacuum will slowly dissipate between flushes, permitting the vacuum pump to quickly renew the vacuum.

Vacuum Pump: The vacuum pump is an electric, straight-through bellows type. It is manufactured of long-lasting polypropylene and draws only 4 to 6 amps of current at 12 VDC. This unique pump design is both an efficient air and liquid pump that handles solids without a problem. It has two duckbill valves on each side of the pump chamber to prevent backflow of waste and vacuum.

Vacuum Generator: The vacuum generator combines the vacuum tank and vacuum pump in one unit. It greatly reduces installation time and eliminates the hose run between the tank and pump. Its compact size makes it especially well-suited to smaller crafts.

Holding Tanks: Holding tanks from Dometic are made of super-strong, 3/8" (9.5mm) thick polyethylene — 50% thicker than most other holding tanks. Each unit has a solid, one-piece construction with no seams for unmatched durability. Tanks come in several capacities and shapes. Contact Dometic for details. A deodorant additive is required to keep the holding tank odor-free. See Deodorants and Special Tissue section for further information.

TankWatch® Level Indicator: The TankWatch unit utilizes micro-float switches which activate an indicator panel. The inspection cap in the holding tank contains the micro-float switch units. The adjustable probe assemblies are flexible polybutylene tubing and are designed to flex when tank contents move.

In-Line Vent Filter: Our SaniGard™ vent filter has special odor-removing filter materials to help keep your boat smelling clean and pleasant. Heavier-than-air malodors accumulate in the holding tank. The SaniGard vent filter has a special type of activated filter media to remove these odors before they offend. Each cartridge is good for an entire season, and is easily replaced for a fresh start. Replacement cartridges are available from your local marine dealer.

Dockside Discharge Deck Fitting: The holding tank is connected to a deck discharge fitting. This fitting, in turn, can be connected to a dockside pump which may have a rubber, cone-shaped nozzle or a cam lock fitting. Refer to Accessories section for further information on the NozAll™ fitting which makes using a dockside pump easy and convenient.

Discharge Pump: Our T-series SaniPump™ discharge pump can run dry without harm and draws just 6 amps at 12 VDC. The discharge pump has a flow rate of just over 5.25 gallons per minute (11.4 liters per minute). Emptying an onboard tank usually takes four to six minutes. The T-pump is connected to a through-hull fitting. Check the section on Marine Sanitation Regulations for information on areas where discharge is allowed.

SYSTEM START-UP

1. Turn on inlet water supply.
2. Turn on electrical power to system.
3. Flush water into system by depressing flush lever until water starts flowing to the vacuum pump, approximately 15 seconds. The vacuum pump will run for approximately 60 to 90 seconds until system reaches operating vacuum level and then will shut off.

PROPER BOWL CLEANING

For stubborn stains, use SeaLand® Toilet Bowl Cleaner (Fig. A). It's manufactured especially for use with SeaLand toilets. In certain locations where water is hard, a build-up of lime may dull the toilet bowl finish. Restore the shine with this SeaLand cleaner. If you cannot find it in your area, contact Dometic for your nearest dealer. If the cleaner is not available, you can also use most non-abrasive bathroom and toilet bowl cleaners (Bar Keeper's Friend® spray cleaner, Clorox® toilet bowl cleaner, SaniFlush® toilet bowl cleaner, etc.). Please follow label instructions.



To avoid damaging the Teflon®-coated seal, DO NOT USE:

- abrasives (Comet®, Soft Scrub® cleansers etc.)
- caustic chemicals (Drano® clog remover, etc.)
- lubricants and cleaners containing alcohols or petroleum distillates (Pam® cooking spray, Pine-Sol® cleaner, WD-40® lubricant, etc.).

WINTERIZING

At the end of each season, the SeaLand toilet should be winterized for storage, by either draining or using potable water-safe antifreeze in the system.

To drain:

1. Thoroughly flush system with fresh water.
2. Empty holding tank.
3. Shut off water supply to toilet(s), and remove inlet waterline (Fig. B).
Do not remove brass cap on bottom of valve.
4. Press flush lever until all water is drained from toilet(s).

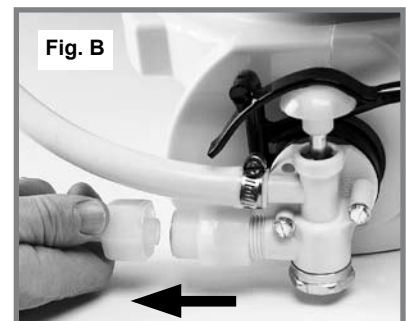

To use antifreeze:

1. Drain potable water tank.
2. Add freshwater antifreeze to potable water tank.
3. Flush potable water antifreeze and water mixture through toilet(s) and into the waste holding tank. Each installation is different, so amounts may vary. User discretion is required to assure adequate protection.
4. Empty holding tank.

NOTE: Use nontoxic antifreeze designated for potable water systems. (See vehicle owner's manual.)

CAUTION: Never use automotive-type antifreeze in freshwater systems.

® Bar Keepers Friend is a registered trademark of SerVaas Laboratories Inc.
® Clorox, Pine-Sol and Soft Scrub are registered trademarks of The Clorox Co.
® Comet is a registered trademark of Prestige Brands International.
® Drano is a registered trademark of S.C. Johnson & Son Inc.

® Pam is a registered trademark of ConAgra Foods.
® Sani-Flush is a registered trademark of Reckitt Benckiser Inc.
® Teflon is a registered trademark of DuPont Co.
® WD-40 is a registered trademark of WD-40 Company.

CLEARING DISCHARGE LINES

Sanitation hoses should be cleared if toilet will not be needed for an extended period of time (more than two weeks).

1. Fill toilet bowl with water and add 4 oz. (120 ml) of biodegradable laundry detergent (should NOT contain bleach).
2. Flush toilet, holding pedal down for about two minutes. Close flush ball.
3. Turn off water supply to toilet.
4. Flush the toilet without water, allowing the vacuum pump to shut off after the flush. Repeat three times. (This procedure will minimize any remaining water in the sanitation hoses.)
5. Turn off power to the vacuum pump.
6. Completely pump out holding tank.

If system will be subjected to freezing temperatures, please follow above procedure, then winterize system as described in this manual.

MAINTENANCE

Maintenance intervals and normal parts replacement vary widely depending on numerous factors such as: type of vessel, frequency of system use, quality of flushing water, etc. The chart below is intended strictly as a general guideline. Owner discretion and consideration of actual usage must be the first basis for determining proper maintenance levels.

Maintenance Procedure	Part Number	Approximate Maintenance Level
Follow cleaning procedures (page 5).	—	Monthly
Tighten all clamps, including base clamp ring.*	—	Annually
Check all wire connections.	—	Annually
Check & tighten water valve mounting screws.	—	Annually
Clean filter screen in water valve.	—	Annually
Check pump and in-line valves.	385310076 (2)	2-3 years or as needed
Check toilet seals.	385316140	3-5 years or as needed
Check vacuum breaker.	385316906	3-5 years or as needed
Check water valve.	385314349	3-5 years or as needed

*See Base Assembly - Page 10.

SPARE PARTS

To calculate total spare parts required, determine number and type of toilets and pumps.

On Board Spare Parts Calculation Chart: (Per System)													
Type of System				Toilet Seal Kit	Toilet Water Valve Kit	S Pump Duckbill Valve Kit	M Pump Duckbill Valve Kit	Toilet Vacuum Breaker	Vacuum Tank Vacuum Switch	Toilet Ring/Clamp Kit	Toilet Ball/Shaft Cartridge Kit	Vacuum Generator Switch Kit	Low-Profile Vacuum Generator Switch Kit
Toilet Series & Quantity	Pump Series & Quantity												
500+	1000	S	M										
1		1		1 each	1 each	2 each							
2		2		1 each	1 each	2 each		1 each			1 each		
	1	1		1 each	1 each	2 each							
	2	2		1 each	1 each	2 each		1 each			1 each		
1			1	1 each	1 each		4 each						
2			1	1 each	1 each		4 each	1 each			1 each		
3			1	1 each	1 each		4 each	1 each	1 each	1 each	1 each	1 each	1 each
4			1	2 each	2 each		4 each	2 each	1 each	1 each	1 each	1 each	1 each
5			1	2 each	2 each		4 each	2 each	1 each	1 each	1 each	1 each	1 each
6			1	2 each	2 each		4 each	2 each	2 each	2 each	2 each	2 each	2 each
	1		1	1 each	1 each		4 each						
	2		1	1 each	1 each		4 each	1 each			1 each		
	3		1	1 each	1 each		4 each	1 each	1 each	1 each	1 each	1 each	1 each
	4		1	2 each	2 each		4 each	2 each	1 each	1 each	1 each	1 each	1 each
	5		1	2 each	2 each		4 each	2 each	1 each	1 each	1 each	1 each	1 each
	6		1	2 each	2 each		4 each	2 each	2 each	2 each	2 each	2 each	2 each

Per Vessel: Vacuum Tester – 530002 (1 each) & Owner's Manual – (1 each)

VACUFLUSH MAINTENANCE KIT

The VacuFlush Maintenance Kit contains replacement parts used in routine maintenance of VacuFlush toilets. A "must" for those who cruise to remote locations. The kit includes vacuum tester, water valve, seal kit, duckbill valves (4) and an owner's manual in a convenient storage container.

VacuFlush
Maintenance Kit
(item number 310228)



ORDERING PARTS

Dometic is ready to assist you in the event service is required. Before calling, please have the following information available. Your cooperation in having this information ready is appreciated and allows us to better meet your needs. Please refer to the Parts Distributor list on Page 15.

1. Toilet Model Number (See following section.)
2. Serial Number
3. Part Number, Description and Quantity (See Parts information.)

TOILET MODEL IDENTIFICATION

DOMETIC CORPORATION
P.O. BOX 38, 13128 STATE RT 226 (800) 321-9886
BIG PRAIRIE, OH 44611 USA

MODEL NO. **000**
SERIAL NUMBER
000000

The above label is located on the toilet base and will show the model number and serial number. If label is not available, please refer to the Dimensional Specifications section for toilet model identification.

PEDESTAL AND PEDAL COVER INSTALLATION

1. With the pedestal cover open, place the back half against the side of the base opposite the flush lever. Rotate the pedestal cover counterclockwise around the back of the base, then move the front half into place.
2. **Tall base unit only**, secure with mounting screw. For **short base units**, simply snap cover closed.
3. Slide pedal cover onto foot pedal rod.
4. Attach pedal cover side plate and secure with two (2) mounting screws. For **short base units**, secure front screw, then press foot pedal down completely to secure second screw.

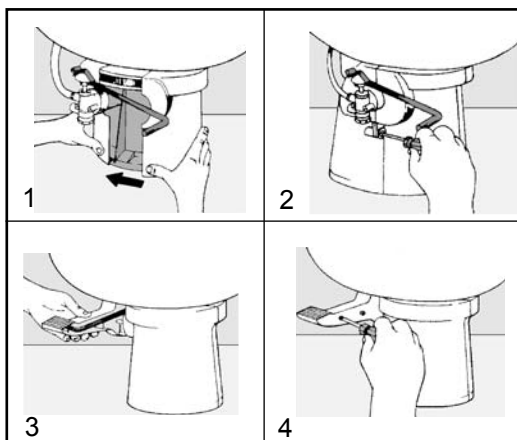

DEODORANTS AND SPECIAL TISSUE

Your VacuFlush sanitation system requires the regular addition of a deodorant product to reduce malodors and to help break down holding tank contents. Several factors should be considered in selecting a deodorant product.

Liquid or Granulated: Liquid products obviously work more quickly by readily going into solution. Granulated powder formulations, on the other hand, have the advantage of requiring less storage space and are less likely to leak if the package is inadvertently damaged.

Formaldehyde versus Non-Formaldehyde: Dometic manufactures both types of deodorants. Generally speaking, formaldehyde formulas control odor very effectively at all temperatures and with all degrees of water hardness. SeaLand® Environment-Friendly brand, which is formaldehyde free, is similarly effective.

Environmental Hazards: If you would like further information on the impact of holding tank deodorants, call or write Dometic at the number and address listed on the back page of this manual. Request a copy of Clean Water Notebook, Volume 5, which provides complete information in this regard.

How Much Deodorant and How to Add It: The deodorant is added directly into the toilet bowl, then flushed into the holding tank. Follow bottle or package instructions. Conditions of extremely warm weather, longer waste holding time and larger tank capacities may require more deodorant treatment. Also, to maintain optimum efficiency in odor control, the waste holding tank should be cleaned thoroughly at least once or more each season depending on use.

Why Not Use Household Toilet Paper in Your SeaLand Toilet. Household tissues often contain adhesives which bond together the paper fibers from which the tissue is made. The adhesives prevent the tissue from breaking apart, and their use in “ultra-low flow” systems can cause system clogging. SeaLand tissue is especially designed for use in low water toilet systems. Its rapid dissolving properties minimize the amount of residual paper in the holding tank and allow deodorizers to work more efficiently.

SeaLand versus Other Brands: Dometic constantly strives to provide our system owners with effective products that have minimal environmental impact and good value. Many other deodorant products do not measure up to our standards of performance and value.

SeaLand® Liquid Deodorant

Two 8-oz. bottles

Part No.
379224008



SeaLand® Liquid Deodorant - Environment Friendly

32-oz. bottle

Part No.
379114032



SeaLand® Granulated Deodorant

Six 2-oz. pouches



Part No.
379626002

SeaLand® Rapid-Dissolving Toilet Tissue

Four 400-sheet rolls

Part No.
379441204



ACCESSORIES

NozAll™ Pumpout Adapter: The NozAll pumpout adapter provides an airtight seal between your boat's deck waste fitting and the pumpout station nozzle. Just screw your personal NozAll adapter into your deck fitting, and be assured of an airtight connection for pumping out holding tank contents. Each item contains a glass-filled nylon NozAll adapter, gasket and vinyl cap. Item number 343502 (1-1/2"-11.5 tpi), 343503 (1-1/4"-11.5tpi), or 343504 (1-1/4"-16tpi).

VacuFlush Status Panel: An ideal add-on to any VacuFlush system. The Status Panel is mounted in the bathroom compartment. A green light indicates sufficient vacuum is available for the next flush. A red light indicates the vacuum level is building and the pump is running. Each panel has an integral circuit breaker which allows the system to be shut down at night. Order part number 500012 (12VDC) or 500024 (24/32VDC).

VacuStat™ Indicator Panel: A desirable accessory for VacuFlush sanitation systems, this panel continuously monitors the status of vacuum for proper toilet operation. Brushed metallic finish complements bath decor. Order part number 700012 (12 VDC) or 700024 (24 VDC).

Optional Vacuum Generator Shut-down Relay: This relay can be added to automatically shut down power to the VacuFlush toilet system to prevent overfilling of the onboard holding tank. Order part number 310289 (12 VDC) or 310290 (24 VDC).

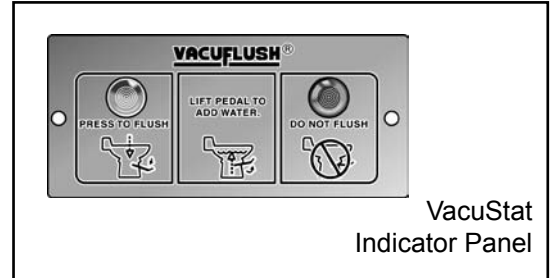
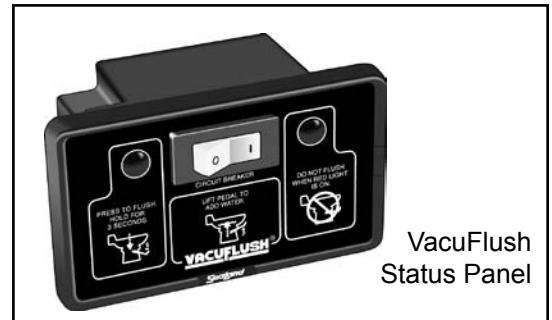

VACUUM TESTER

Dometic has developed a simple tool to assist in identifying the location of vacuum leaks. The vacuum tester consists of a vacuum gauge and a cone-shaped plug. Inserting the plug in the inlet of the vacuum tank or generator isolates the toilet from the system. In this way a troublesome leak can easily be located in either system.

Order only the Vacuum Tester (Part Number 530002) or as part of the complete system maintenance kit (Part Number 310228).

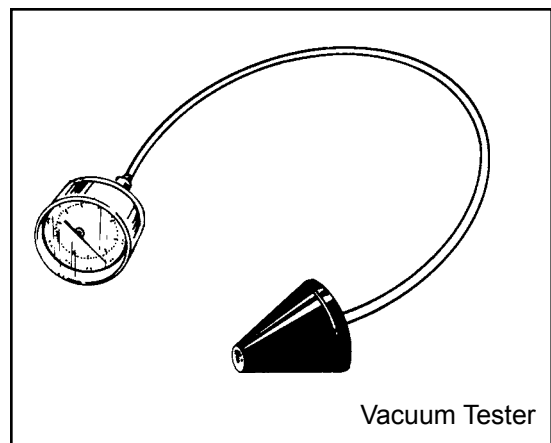

SERVICE TIP

Checking for water leaks behind or under toilets or other appliances can make it difficult to locate the source. Dripping water at room temperature makes it difficult to feel wetness. Taking four or five sheets of toilet tissue and wiping all seams and waterline connections offers a simple means of locating the general area of the leakage. Start at the top of the unit since gravity will cause a leak to run downward. When the tissue comes in contact with the leaking water, it will immediately change texture.

TROUBLESHOOTING GUIDE

BASE ASSEMBLY

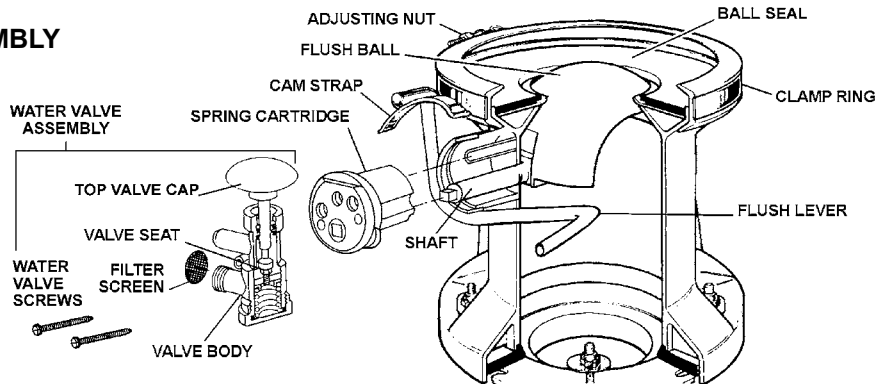

REAR VIEW, VACUUM TOILET

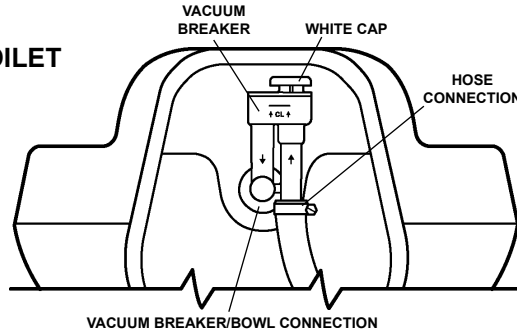

Problem	Possible Cause	Service Instructions
1. Water will not stay in bowl.	<ul style="list-style-type: none"> a. Loose clamp ring. b. Improper seal around flush ball due to dirt or debris on flush ball. c. Worn or damaged seal. d. Worn or damaged flush ball. 	<ul style="list-style-type: none"> a. Tighten clamp ring adjusting nut. b. Inspect flush ball and seal for foreign debris. Clean flush ball and seal if needed. c. Replace seal. d. Replace flush ball.
2. Plastic flush ball will not close completely.	<ul style="list-style-type: none"> a. Too much friction between flush ball and ball seal. b. Water valve screws are too tight. c. Defective spring cartridge. 	<ul style="list-style-type: none"> a. Lubricate between flush ball and ball seal with furniture polish (e.g. Pledge® furniture polish). b. Loosen screws slightly. c. Check spring tension by pushing flush lever down, then release it suddenly. If lever does not snap back into original position, replace spring cartridge.
3. Flush ball will not open.	<ul style="list-style-type: none"> a. Broken shaft. b. Shaft not fully engaged in the spring cartridge. 	<ul style="list-style-type: none"> a. Replace shaft. b. Put pressure on shaft from under the flush ball (pushing into spring cartridge) until it engages. You may have to rotate flush ball slightly until shaft lines up with square in spring cartridge.
4. Water does not shut off in toilet (toilet overflows).	<ul style="list-style-type: none"> a. Not enough clearance between cam strap and top of water valve cap. b. Dirt lodged in water valve seal. 	<ul style="list-style-type: none"> a. Adjust cam strap to have .02" (.5mm) minimum clearance with top of valve cap. b. Disassemble and clean water valve.
5. Water does not enter toilet bowl properly.	<ul style="list-style-type: none"> a. Insufficient water flow rate at toilet. b. Water valve clogged. c. Plugged rim wash holes in toilet. 	<ul style="list-style-type: none"> a. Check water flow rate at toilet. Rate should be 2 gpm (7.6 lpm) at toilet. b. Remove and clean screen located at inlet of water valve. c. Clean holes. If still a problem, replace the toilet bowl.

TROUBLESHOOTING GUIDE

Problem	Possible Cause	Service Instructions
6. Lifting foot pedal does not add water to the bowl.	a. Too much clearance between the cam strap and water valve.	a. Adjust cam strap so clearance is .06 inches (1.5mm) maximum.
7. Water leaking from water valve.	a. Water valve body cracked due to freeze damage. b. Water line connection is loose or not seated properly. c. Defective water valve. d. Stripped threads.	a. Replace water valve. b. Insure that threads are not cross-threaded and tighten. c. Replace water valve. d. Replace water valve.
8. Water leaking from rear of toilet bowl.	a. Worn or defective vacuum breaker. b. Loose vacuum breaker. c. Cracked or defective toilet bowl.	a. Remove white cap from vacuum breaker. Flush toilet. If water leaks during flush, vacuum breaker needs to be replaced. b. Secure vacuum breaker connection. c. Replace toilet bowl.
9. Water is leaking from the base/toilet connection.	a. Clamp ring may be loose. b. Ball seals may be worn or defective.	a. Remove plastic base cover (on applicable models) and tighten the clamp ring. b. Replace ball seals.
10. Vacuum pump running too often between flushes. (See Vacuum Tester Information on page 9.)	a. Water leaks out of bowl between flush ball and ball seal. b. Vacuum line leak.	a. Leave small amount of water in bowl. If water is sucked from bowl, see problems 1 and 2. b. Tighten all connections at toilet, vacuum generator or vacuum holding tank (including hose clamps and threaded spin nuts). If leaks persists, contact SeaLand Product Customer Service.
11. Vacuum pump will not shut off.	a. A vacuum leak exists. b. Insufficient vacuum (pump creates less than 10 inches Hg). c. Faulty vacuum switch (pump creates more than 10 inches Hg). d. Improper wiring. e. Bellows not pumping.	a. See problem 9b. b. Isolate pump and use vacuum gauge to check vacuum levels. Could be a plugged discharge line or worn duckbill valves. c. Replace vacuum switch. d. Refer to wiring diagram to check for proper wiring. e. Tighten set screw in eccentric to motor shaft. Otherwise, check for damage to bellows and motor shaft. Replace if necessary.
12. Vacuum pump will not run.	a. No electrical power. b. Loose or broken electrical wiring. c. Improper electrical connections. d. Faulty vacuum switch. e. Faulty motor. f. Shut-down relay prevents pumping.	a. Check input power, circuit breaker and fuse. b. Tighten or reconnect wires at vacuum pump and tank, vacuum generator, or vacuum holding tank. c. Make certain wires at vacuum switch are connected to the "B" terminals. d. To check vacuum switch, short across "B" terminals with jumper wire. e. Replace motor. f. Empty the holding tank.

TROUBLESHOOTING GUIDE

Problem	Possible Cause	Service Instructions
<p>13. Vacuum pump is running too slow, overheating, blowing fuses or circuit breaker.</p>	<ul style="list-style-type: none"> a. Gear motor is worn or defective. b. Plugged vent line or vent filter. c. Blockage in discharge line. d. Improper wire size. e. Improper voltage. f. Vacuum pump bellows clogged with tissue. 	<ul style="list-style-type: none"> a. Check motor and replace if necessary. b. Disassemble and clean out vent line. Replace vent filter if necessary. c. Disassemble and clean discharge line. Be certain that in-line valves (duckbill valves) and seacock are in proper position. d. Wire size too small. Check electrical diagram for proper wire size for voltage of pump used. e. Check input power for low voltage. f. Remove and clean bellows assembly. (When flushing toilet, using more water may alleviate this problem.)
<p>14. Toilet will not flush. (No vacuum.) See problems 3 and 15 if necessary.</p>	<ul style="list-style-type: none"> a. There is a blockage in the system. b. Pump will not run. c. Duckbill valves in vacuum pump are inverted due to blocked discharge line or an attempt to pump out against closed seacock. 	<ul style="list-style-type: none"> a. Open flush ball and check the 1-inch (25mm) orifice at the bottom of the base for blockage and dislodge it. Never use drain-opening or other household plumbing chemicals. If blockage is not in base, it may be found in these locations: <ul style="list-style-type: none"> • outlet of vacuum tank • inlet of vacuum generator • diptube of vacuum generator • inlet of vacuum pump b. See problem 12. c. Replace duckbill valves, making sure they point in the correct direction.
<p>15. Blockage between toilet and vacuum generator.</p>	<ul style="list-style-type: none"> a. Collapsed vacuum line. b. Sharp bends or kinks in vacuum hose. c. Improper operation of toilet. d. Foreign objects were flushed down toilet. 	<ul style="list-style-type: none"> a. Inspect vacuum line for collapsed condition and replace line if needed. b. Inspect vacuum hose for kinks or bends. If less than 8.5-inches (216mm) radius on any bend, reposition hose to achieve minimum 8.5-inch bend radius. c. Make sure each person using toilet knows correct procedure. d. DO NOT flush any non-dissolving items (i.e. sanitary napkins, facial tissue, wet strength tissue, paper towels, etc.) or excessive toilet tissue down toilet. Rapid-dissolving SeaLand brand toilet tissue is best.
<p>16. Pump emits odor.</p>	<ul style="list-style-type: none"> a. Loose or defective hose connection on pump. b. Loose intake or discharge fittings on pump. c. Worn, torn or punctured pump bellows (vacuum generator) or diaphragm (vacuum holding tank). 	<ul style="list-style-type: none"> a. Tighten connections or replace hose and make new connections. b. Tighten intake or discharge fittings on pump. Replace nipples or adapters if necessary. c. Replace pump bellows or diaphragm.

DIMENSIONAL SPECIFICATIONS

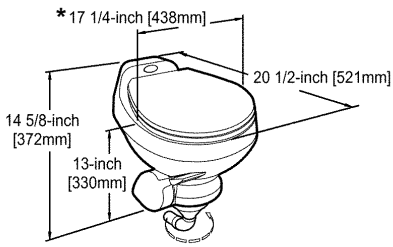

Model 506+

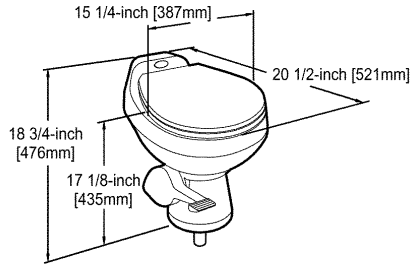

Model 508+

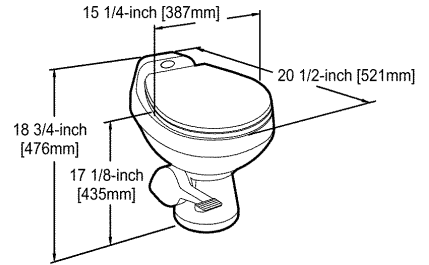

Model 547/548+

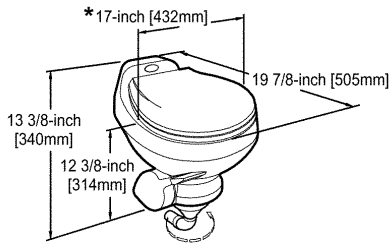

Model 1006

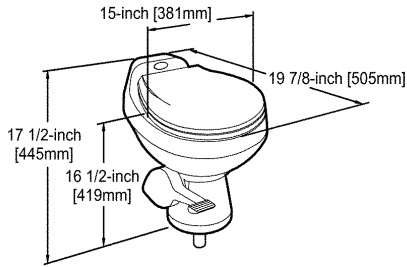

Model 1008

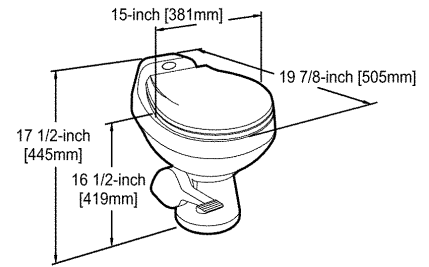

Model 1047/1048

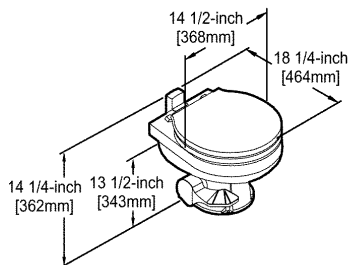

Model 147/148

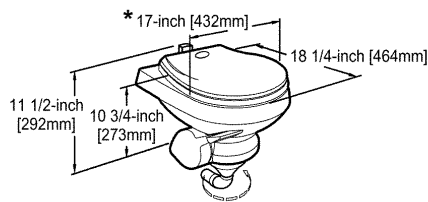

Model 706

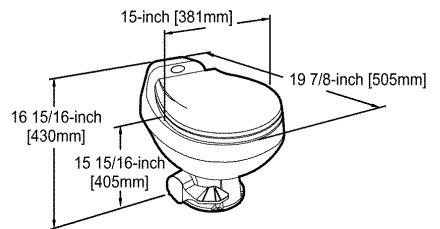

Model 1147/1148

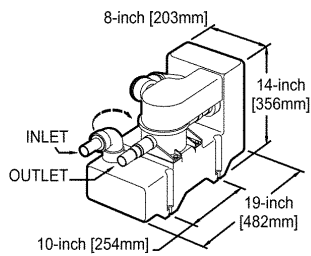

Vacuum Generator

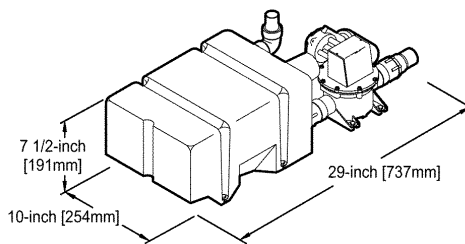

Low-Profile Vacuum Generator

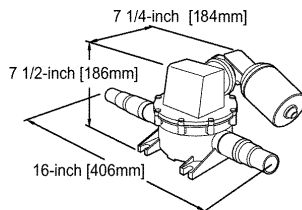

Vacuum Pump

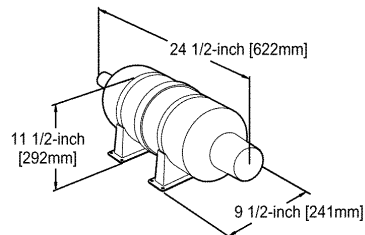

Vacuum Tank

* Width measurement includes flush pedal.

Toilet dimensions may vary $\pm 3/8$ -inch (10mm).

WIRING DIAGRAMS

VACUUM GENERATOR

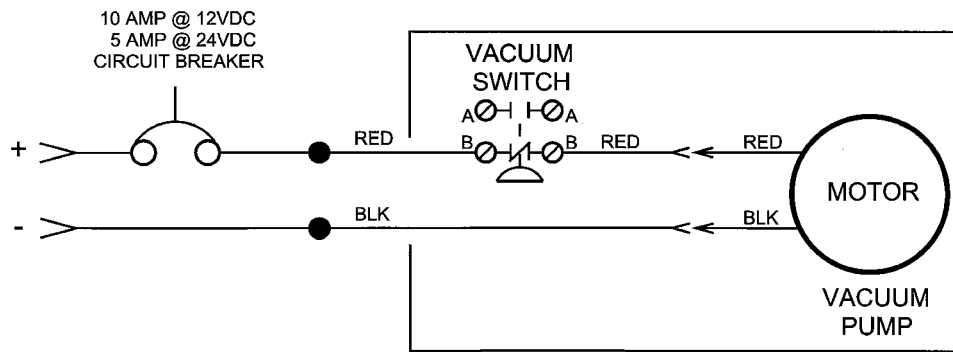

VACUUM PUMP

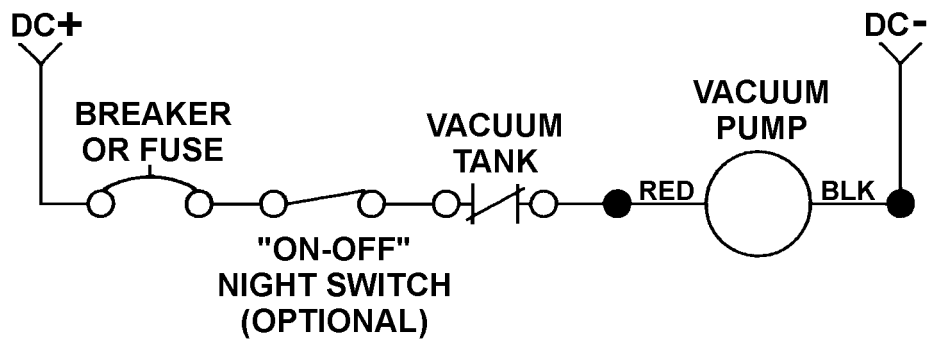

PARTS DISTRIBUTORS

There is a strong, worldwide network to assist in servicing and maintaining your sanitation system. For the Authorized Service Center near you, please call from 8:00 a.m. to 5:00 p.m. (ET) Monday through Friday. You may also write us at Dometic Corp., P.O. Box 38, Big Prairie Ohio 44611.

You may also contact or have your local dealer contact the Parts Distributor nearest you for quick response to your replacement parts needs. They carry a complete inventory for the SeaLand product line.

Telephone: 1 800-321-9886 U.S.A. and Canada
330-496-3211 International

Fax: 330-496-3097 U.S.A. and Canada
330-496-3220 International

U.S.A.

MASTER SANITATION DISTRIBUTORS

U.S.A. – North Central **(IL, IN, KY, MI, OH)**

Midwest Marine Supply
24300 Jefferson Ave.
St. Clair Shores, MI 48080
Tel: 586-778-8950
800-860-1540
Fax: 586-778-6108
E-mail: midwestmarine@yahoo.com

U.S.A. - Northeast **(CT, DE, DC, MA, MD, ME, NH, NJ, NY, PA, RI, VA, VT, WV)**

Northeast Marine Sanitation
69 Florida Street
Farmingdale, NY 11735
Tel: 631-752-7606
800-352-4323
Fax: 631-752-7615
888-283-7606
E-mail: info@northeast sanitation.com

U.S.A. - Northwest **(AK, ID, MT, OR, WA, WY)**

Marine Sanitation, Inc.
1900 N. Northlake Way, Suite 121
Seattle, WA 98103
Tel: 206-633-1110
800-624-9111
Fax: 206-633-0317
E-mail: marinesan@mindspring.com

U.S.A. - South Central **(AR, KS, LA, MO, MS, NM, OK, TX)**

AER Supply
P.O. Box 349
2301 Nasa Road #1
Seabrook, TX 77586
Tel: 281-474-3276
800-767-7606
Fax: 281-474-2714
E-mail: sales@aersupply.com

U.S.A. - Southeast **(AL, FL, GA, NC, PR, SC, TN, VI)**

Environmental Marine
111 S.W. 23rd Street, Suite A
Fort Lauderdale, FL 33315
Tel: 954-522-2626
800-522-2656
Fax: 954-522-5152
E-mail: info@environmentalmarine.com

U.S.A. - Southwest **(AZ, CO, NV, UT, CA-south)**

Ardemco Marine Specialties
778 West 17th Street
Costa Mesa, CA 92627
Tel: 949-722-7672
800-253-0115
Fax: 949-642-9582
E-mail: info@ardemco.com

U.S.A. – Upper Midwest **(IA, MN, NE, ND, SD, WI)**

PowerHouse Marine
518 Logan
La Crosse, WI 54603
Tel: 608-784-9580
888-752-4539
Fax: 608-784-8422
E-mail: dave@powerhousemarine.com

U.S.A. – Northern California

Fox Marine
6545 Caballero
Buena Park, CA 90620
Tel: 800-826-2873
Fax: 714-690-1511
E-mail: foxmarco@pacificsupplyco.com

CANADA

MASTER SANITATION DISTRIBUTORS

Canada - East

Eastern Marine Systems, Inc.
12-A Leslie Street
Toronto, Ontario M4M 3H7
Tel: 416-465-1668
888-764-1111
Fax: 416-465-2098
E-mail: info@eastmar.com

Canada - West

Western Marine Company
1494 Powell Street
Vancouver, BC V5L 5B5
Tel: 604-253-7721
800-663-0600
Fax: 604-253-2656
800-663-6790
E-mail: sales@westernmarine.com

INTERNATIONAL

SEALAND SANITATION SYSTEM DISTRIBUTORS

Call 1-800-321-9886, email us at sealand@dometicus.com, or visit www.DometicSanitation.com for the distributor nearest you.

MANUFACTURER'S ONE-YEAR LIMITED WARRANTY

Dometic Corporation warrants, to the original purchaser only, that this VacuFlush vacuum discharge toilet, if used for personal, family or household-like purposes, and if installed according to Dometic's recommended procedures, is free from defects in material and workmanship for a period of one (1) year from the date of purchase.

If this Dometic product is placed in commercial or business use, it will be warranted, to the original purchaser only, to be free of defects in material and workmanship for a period of ninety (90) days from the date of purchase.

Dometic reserves the right to replace or repair any part of this product that proves, upon inspection by Dometic, to be defective in material or workmanship. All labor and transportation costs or charges incidental to warranty service are to be borne by the purchaser-user.

EXCLUSIONS

IN NO EVENT SHALL **DOMETIC** BE LIABLE FOR INCIDENTAL OR CONSEQUENTIAL DAMAGES, FOR DAMAGES RESULTING FROM IMPROPER INSTALLATION, OR FOR DAMAGES CAUSED BY NEGLIGENCE, ABUSE, ALTERATION, OR USE OF UNAUTHORIZED COMPONENTS. THIS INCLUDES FAILURES WHICH MAY RESULT FROM NOT FOLLOWING THE WINTERIZATION OR CLEANING PROCEDURES AS DESCRIBED IN THIS MANUAL. ALL IMPLIED WARRANTIES, INCLUDING ANY IMPLIED WARRANTY OF MERCHANTABILITY OR FITNESS FOR ANY PARTICULAR PURPOSE, ARE LIMITED TO A PERIOD OF ONE (1) YEAR FROM DATE OF PURCHASE.

IMPLIED WARRANTIES

No person is authorized to change, add to, or create any warranty or obligation other than that set forth herein.

Implied warranties, including those of merchantability and fitness for a particular purpose, are limited to one (1) year from the date of purchase for products used for personal, family or household-like purposes, and ninety (90) days from the date of purchase for products placed in commercial or business use.

OTHER RIGHTS

Some states do not allow limitations on the duration of an implied warranty, and some states do not allow exclusions or limitations regarding incidental or consequential damages; so, the above limitations may not apply to you. This warranty gives you specific legal rights, and you may have other rights which vary from state to state.

To obtain warranty service, first contact your local dealer from whom you purchased this product.



Dometic is a customer driven, world-leading provider of innovative leisure products for the caravan, motorhome and marine markets. Dometic offers a complete range of air conditioners, refrigerators, awnings, cookers, sanitation systems, lighting, windows, doors and other equipment that makes leisure life more comfortable away from home.

Dometic also provides refrigerators for specific use in hotel rooms, offices and for storage of medical products and wine. Dometic's products are sold in almost 100 countries and are produced mainly in Dometic's own production facilities around the world. Dometic has more than 4,400 employees.

Dometic Sanitation Corporation
13128 State Rt 226, PO Box 38
Big Prairie, OH 44611
SeaLand Product Customer Service: 1-800-321-9886
(8:00 a.m. - 5:00 p.m. ET)
Email: sealand@dometicusa.com
www.DometicSanitation.com

® Registered; ™ Trademark of Dometic Corporation
© Dometic Corporation